



GARDTEC

Revision	Date	Approved	Name

Part Number:

AFM-162B

1.MATERIAL:

(1)FRAME:ALUMINUM WITH 0.6mm THICKNESS.

(2)MESH:24#/25.4mm STAINLESS STEEL.

2.FINISH:BLACK E.D.

3.GENERAL TOLERANCE UNLESS NOTED:±0.5mm.

4.UNIT:mm.

5.RoHS COMPLIANT.

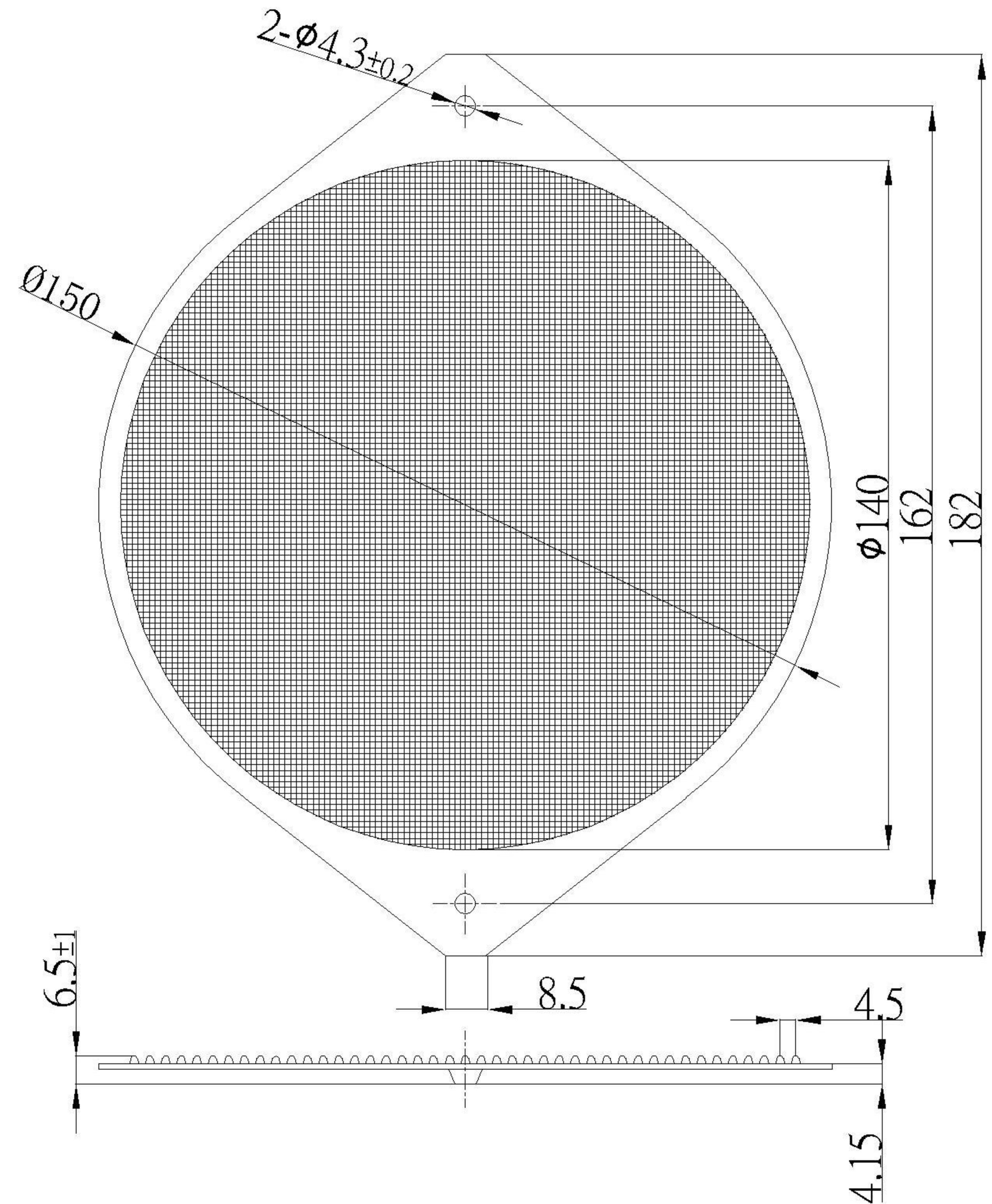

These drawings are the property of Gardtec, Inc and cannot be reproduced for or communicated to a third party without the express written permission of Gardtec, Inc.