



**GARDTEC**

Revision	Date	Approved	Name

Part Number:  
**SC80-W6**

Material: C1008 Steel  
Finish: Bright Nickel Chrome Plating  
Ring Diameter: 1.6mm  
Rib Diameter: 1.6mm  
General Tolerance Unless Noted:  $\pm 0.5$ mm  
Unit: mm  
RoHS Compliant

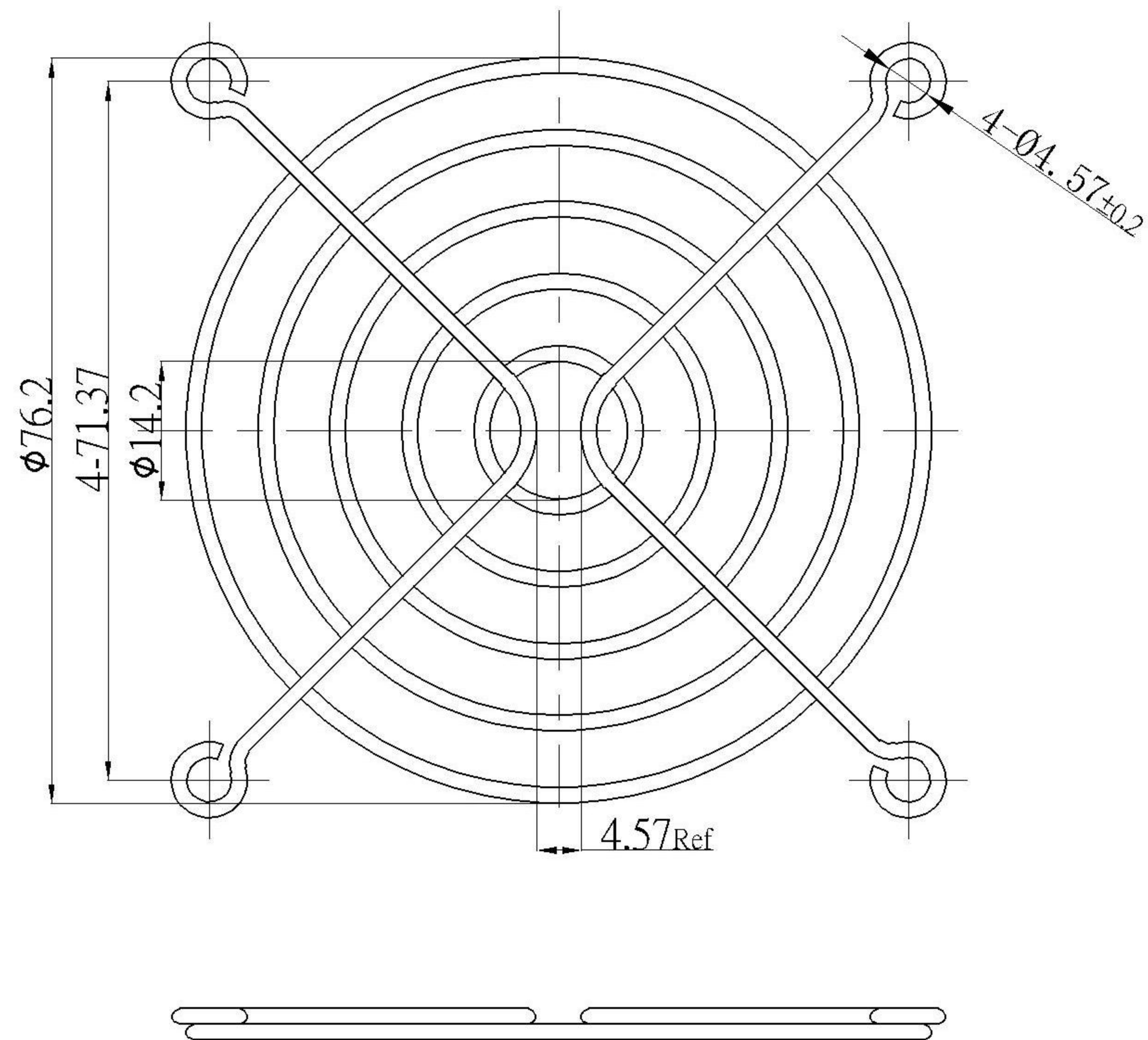

These drawings are the property of Gardtec, Inc and cannot be reproduced for or communicated to a third party without the express written permission of Gardtec, Inc.